

Wash  
Your  
Hands

Sequencing



© 2018 Stacey Jones at Simple Living. Creative Learning



All rights reserved. No part of this book may be reproduced, stored or transmitted in any form by any means without prior permission of the publisher.

This workbook is licensed for personal/family use only.

YOU MAY:

- Use these files for personal use only.
  - Use in your personal classroom
  - Download the files to your personal computer.
- Print as many copies as you would like to use for your personal use.
- Direct other to our website: <https://simplelivingcreativelearning.com>

YOU MAY NOT:

- Edit any of these printables.
- Share the files with anyone else.
- Store or sell them on any website.
  - Claim them as your own.
- Print and sell or distribute them to others

Graphics and Fonts:



# Sequencing Activity

## How to Wash Your Hands.

Read the story and cut out the pictures and paste in the correct order.

To wash your hands, first you need to turn on the tap and wet your hands. Then, put soap on your hands before rubbing the together. Next you will need to rinse the soap off your hands. Lastly, dry your hands until they are completely dry.

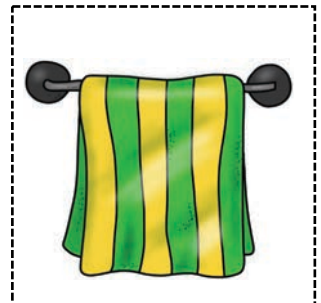
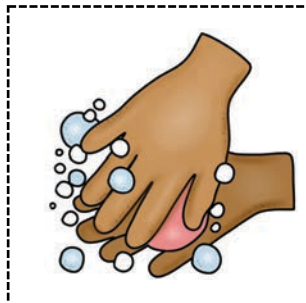
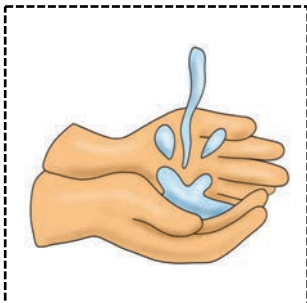
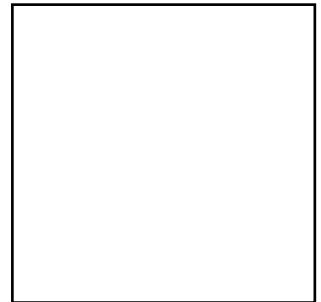
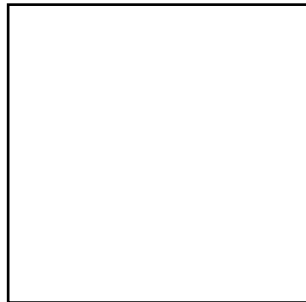
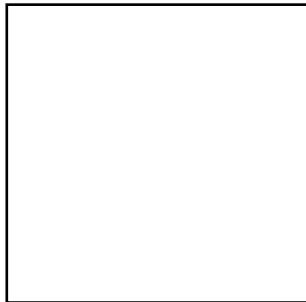
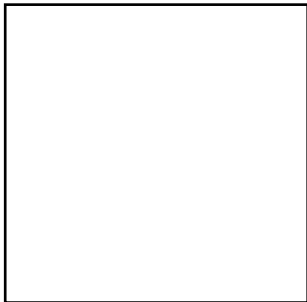

# How to Wash Your Hands



To wash your hands, first turn the tap on and wet your hands.



Then apply soap to your hands and rub it all over. You can use a liquid soap or a cake of soap.



Next, rinse off all the soap.

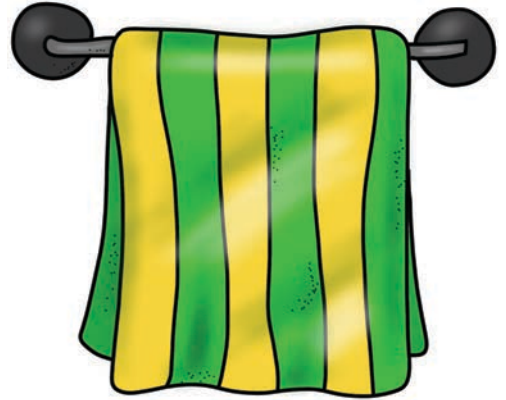
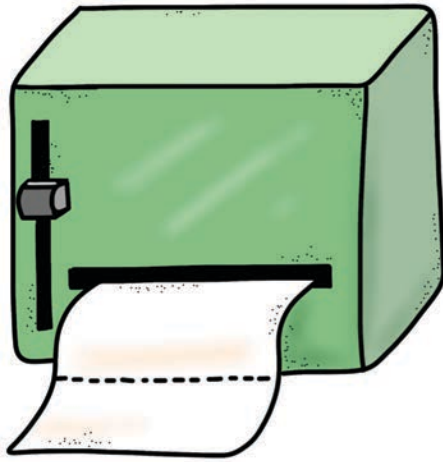

Lastly, dry your hands with paper towel or a hand towel.

# Let's Wash Our Hands



You will need:

---

---

---

---

---

---

---

---

---

---



First,

Handwriting practice lines for the word "First". The section contains five sets of lines, each consisting of a solid top line, a dashed middle line, and a solid bottom line. A decorative bubble graphic with the word "Soap" is located at the bottom right of this section.

Second,

Handwriting practice lines for the word "Second". The section contains five sets of lines, each consisting of a solid top line, a dashed middle line, and a solid bottom line. A decorative bubble graphic with the word "Soap" is located at the bottom right of this section.

Third,

Handwriting practice lines for the word "Third". The section contains four sets of lines, each consisting of a solid top line, a dashed middle line, and a solid bottom line. A decorative bubble graphic with the word "Soap" is located at the bottom right of the section.



Fourth,

Handwriting practice lines for the word "Fourth". The section contains four sets of lines, each consisting of a solid top line, a dashed middle line, and a solid bottom line. A decorative bubble graphic with the word "Soap" is located at the bottom right of the section.



Fifth,

Handwriting practice lines for the word "Fifth". The page contains five sets of horizontal lines, each consisting of a solid top line, a dashed middle line, and a solid bottom line. A decorative bubble graphic with the word "Soap" is located at the bottom right of the page.



Sixth,

Handwriting practice lines for the word "Sixth". The page contains five sets of horizontal lines, each consisting of a solid top line, a dashed middle line, and a solid bottom line. A decorative bubble graphic with the word "Soap" is located at the bottom right of the page.



Seventh,

Handwriting practice lines for the word "Seventh". The section contains three sets of horizontal lines, each consisting of a solid top line, a dashed middle line, and a solid bottom line. A decorative bubble graphic with the word "Soap" is located at the bottom right of this section.

Eighth,

Handwriting practice lines for the word "Eighth". The section contains three sets of horizontal lines, each consisting of a solid top line, a dashed middle line, and a solid bottom line. A decorative bubble graphic with the word "Soap" is located at the bottom right of this section.

Ninth,

Handwriting practice lines for the word "Ninth". The section contains four sets of horizontal lines, each consisting of a solid top line, a dashed middle line, and a solid bottom line. A decorative bubble graphic with the word "Soap" is located at the bottom right of the section.



Tenth,

Handwriting practice lines for the word "Tenth". The section contains four sets of horizontal lines, each consisting of a solid top line, a dashed middle line, and a solid bottom line. A decorative bubble graphic with the word "Soap" is located at the bottom right of the section.



Handwriting practice lines consisting of four sets of three horizontal lines (top solid, middle dashed, bottom solid). A decorative bubble graphic with the word "Soap" is located at the bottom right of the section.

Handwriting practice lines consisting of four sets of three horizontal lines (top solid, middle dashed, bottom solid). A decorative bubble graphic with the word "Soap" is located at the bottom right of the section.

# How to Wash Your Hands



Materials Needed:

A series of ten horizontal writing lines for a list. Each line set consists of a solid top line, a dashed middle line, and a solid bottom line. A solid black dot is positioned at the start of each line set on the left side.

# How to Wash Your Hands



Steps:

1.

---

---

---

---

---

2.

---

---

---

---

---

3.

---

---

---

---

---

4.

---

---

---

---

---

5.

---

---

---

---

---

# How to Wash Your Hands



Steps:

6.

---

---

---

---

---

---

7.

---

---

---

---

---

---

8.

---

---

---

---

---

---

9.

---

---

---

---

---

---

10.

---

---

---

---

---

---

# How to Wash Your Hands Sequencing

1

2

3

4

5

Wash  
Your  
Hands



# How to Wash Your Hands

Cut out and paste on the previous page.

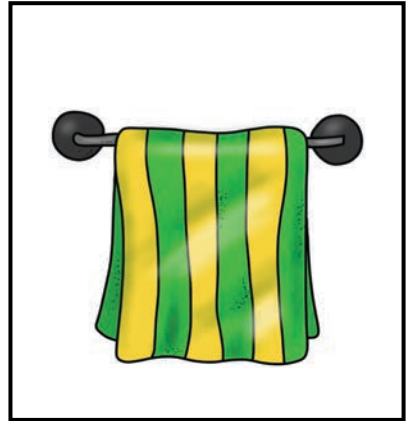
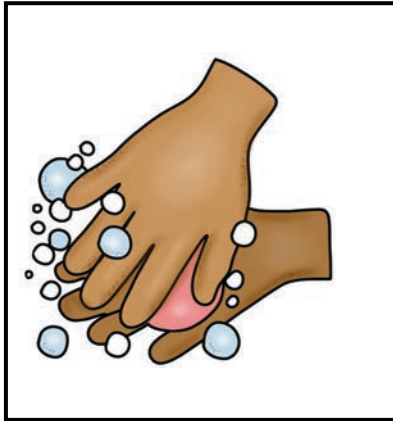
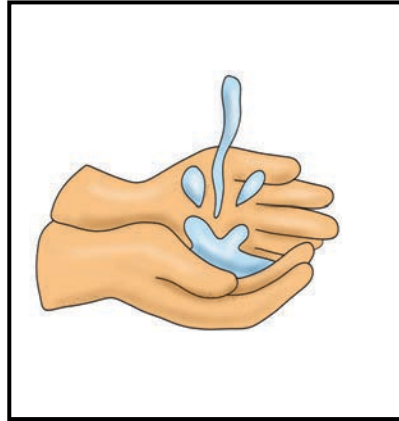
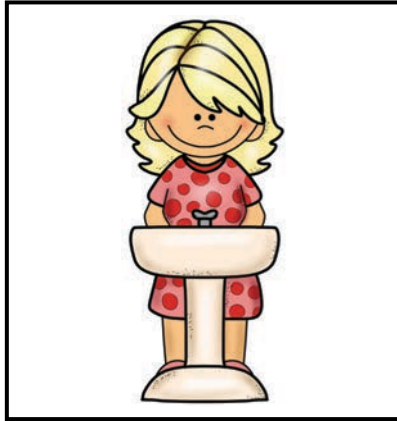

extras ~  
depending on  
what kids what to  
use

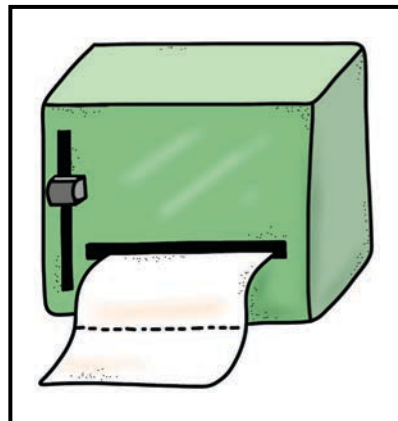

# How to Wash Your Hands

Cut out and paste on the previous page.

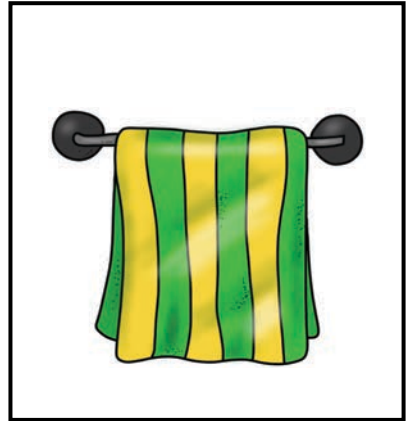
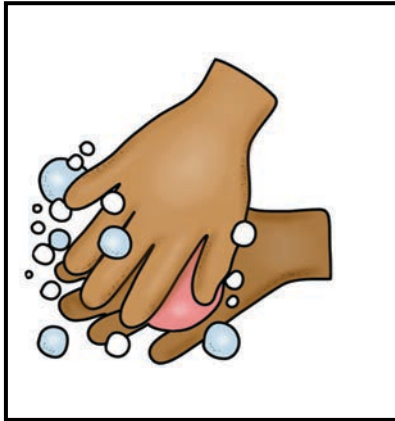
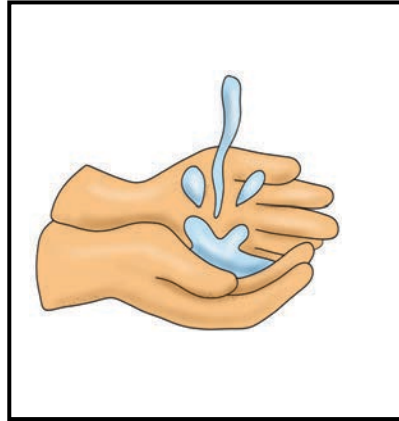

extras ~  
depending on  
what kids what to  
use

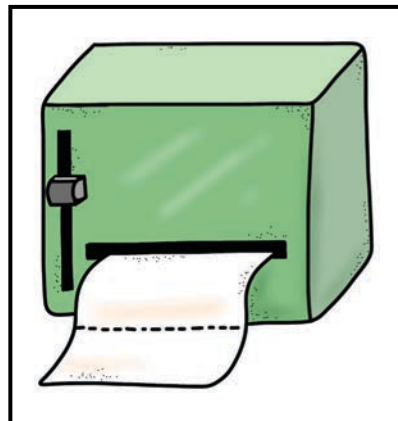

# Sequencing Colouring Page

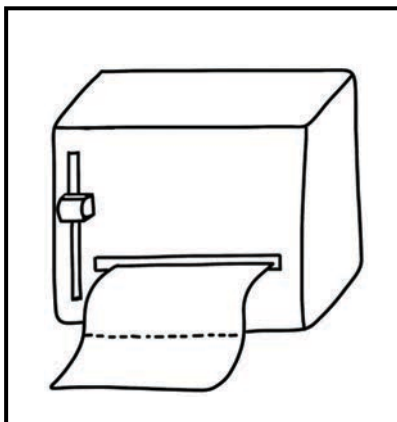
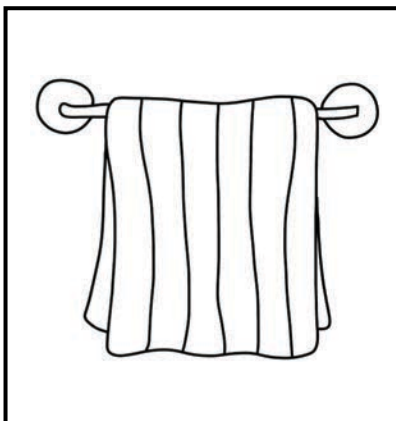
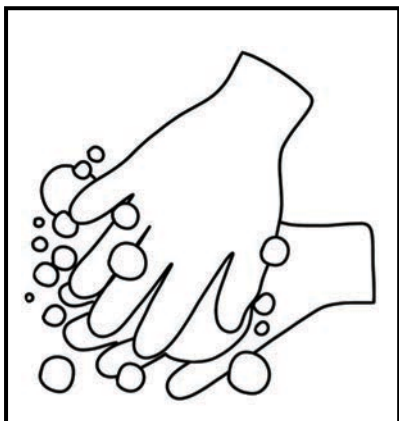
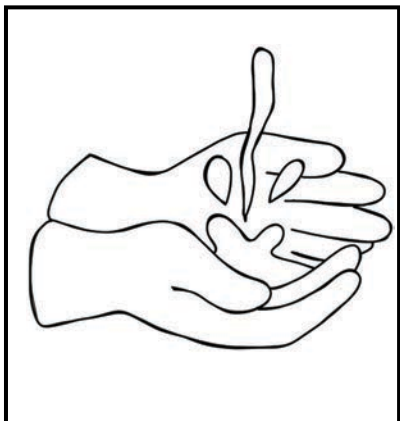

# Sequencing Colouring Page

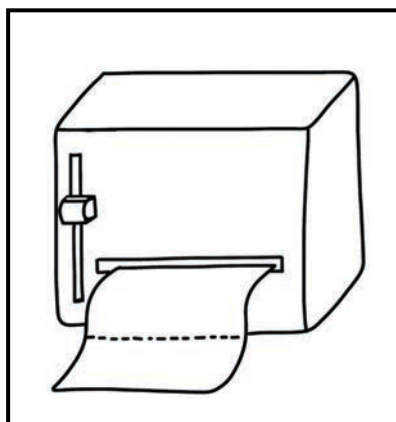
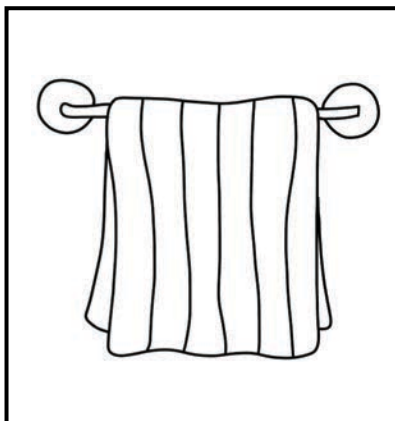
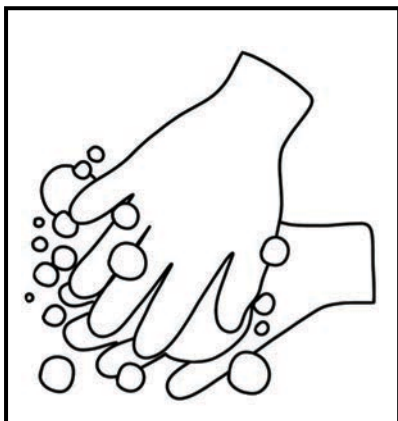
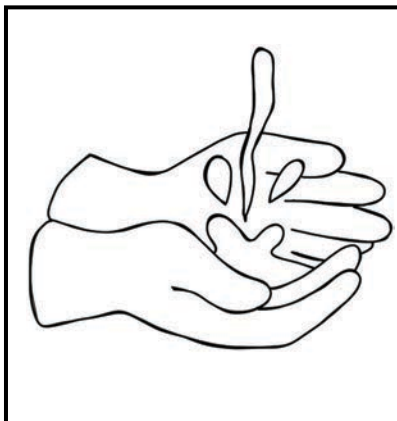

# How to Wash Your Hands

first

second

third

fourth

fifth

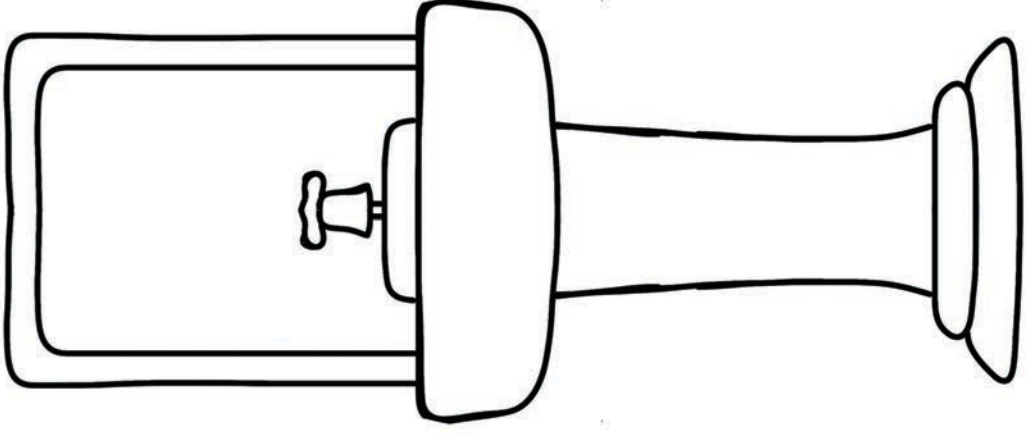

# How to Wash Your Hands

Cut out the boxes below and paste them in the correct order on the previous page.

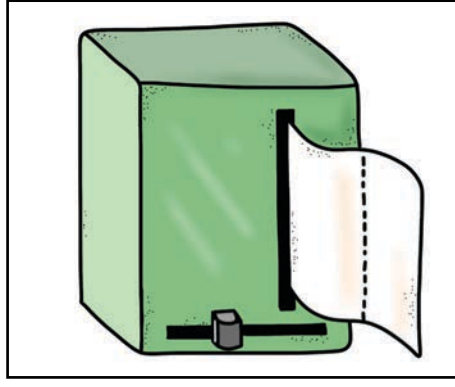
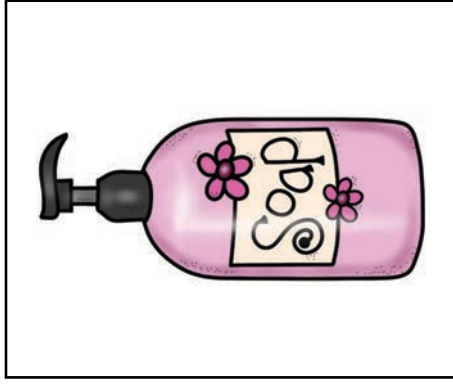
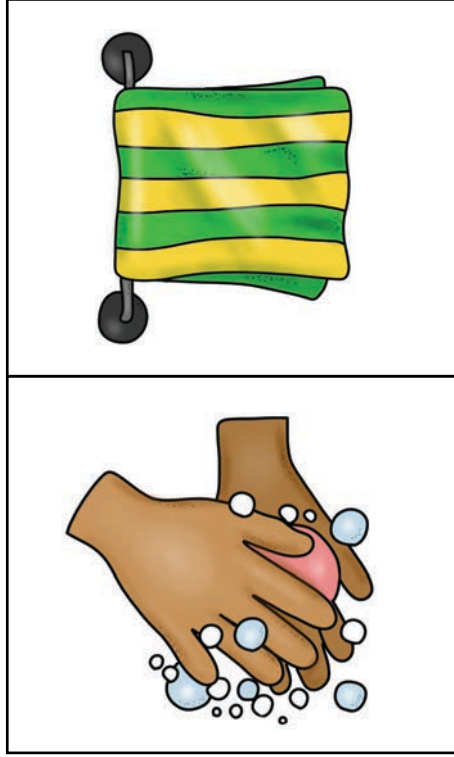
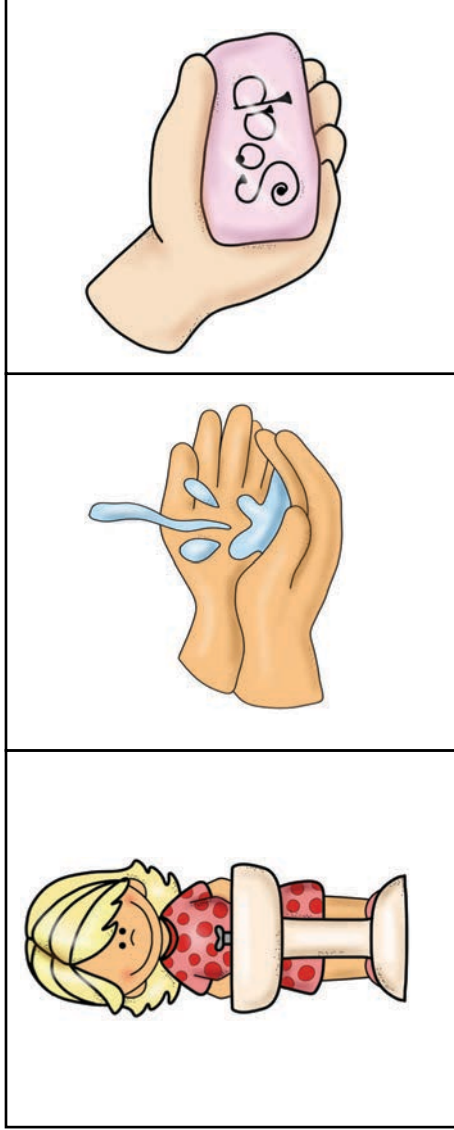

# How to Wash Your Hands

Cut out the boxes below and paste them in the correct order on the previous page.

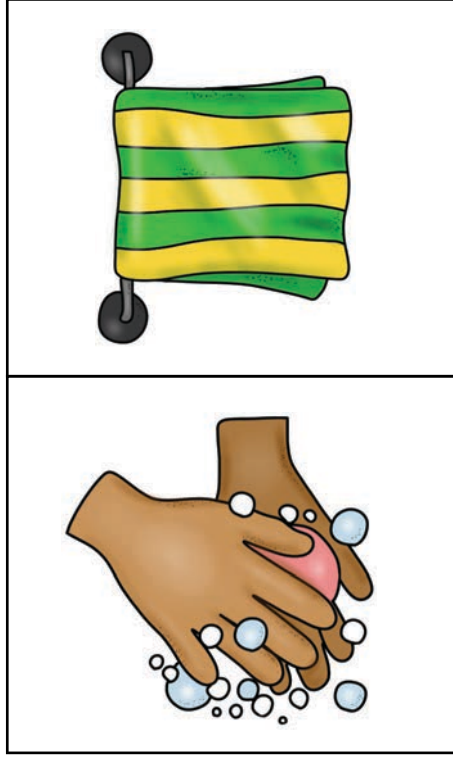
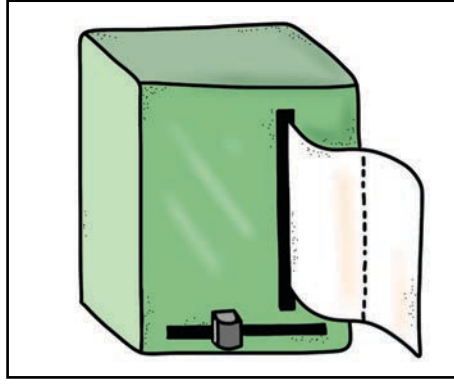
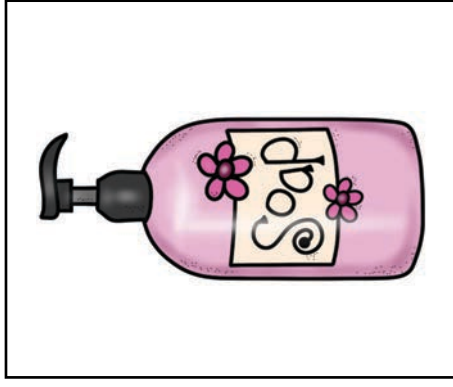
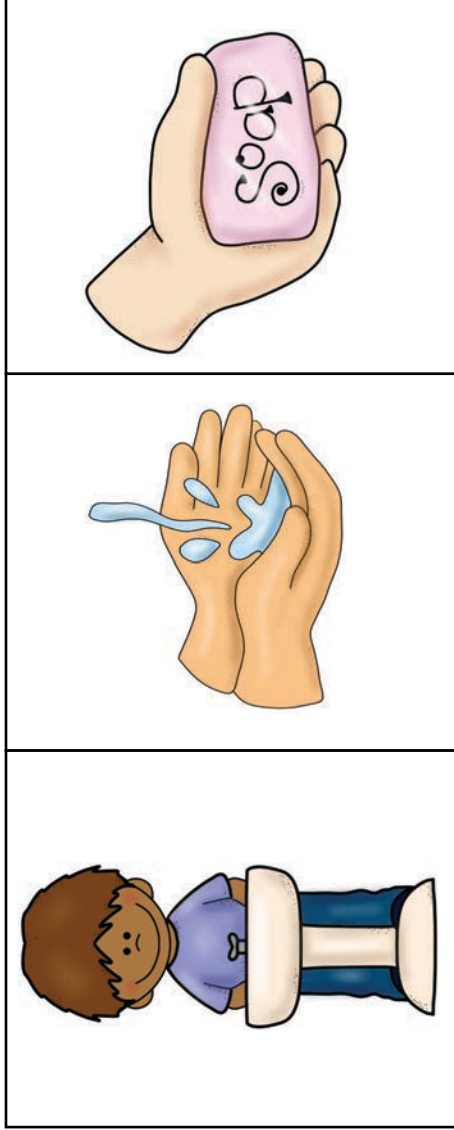

# How to Wash Your Hands Sequencing

Draw a line to connect the picture to the correct order number.



first

second

third

fourth

fifth

# How to Wash Your Hands Sequencing

Draw a line to connect the picture to the correct order number.



first

second

third

fourth

fifth

# How to Wash Your Hands Sequencing

Draw a line to connect the picture to the correct order number.

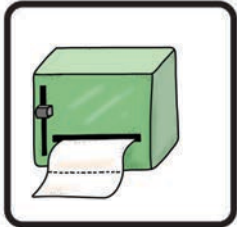

first

second

third

fourth

fifth

# How to Wash Your Hands Sequencing

Draw a line to connect the picture to the correct order number.

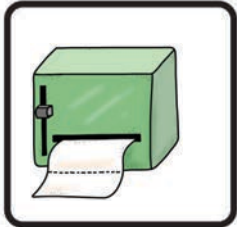

first

second

third

fourth

fifth

Cut out on the gray dotted line and glue a paddle pop (lollipop) stick to the back. Use the puppets as you write a story on how to send a valentine.

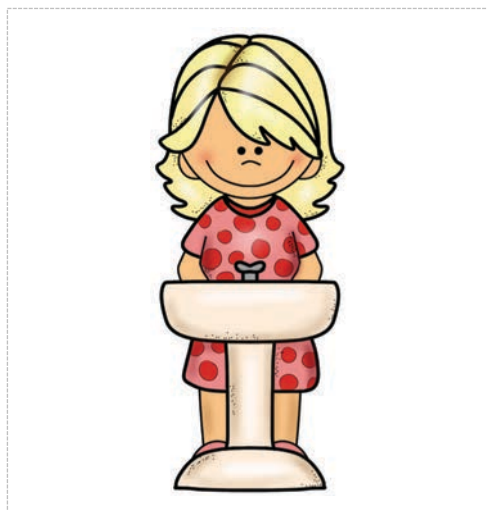
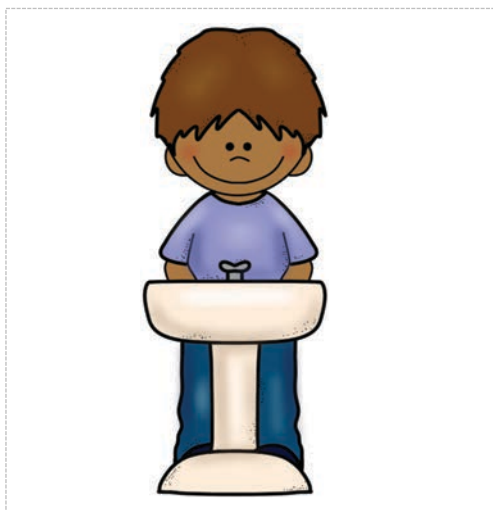

Cut out on the gray dotted line and glue a paddle pop (lollipop) stick to the back. Use the puppets as you write a story on how to send a valentine.

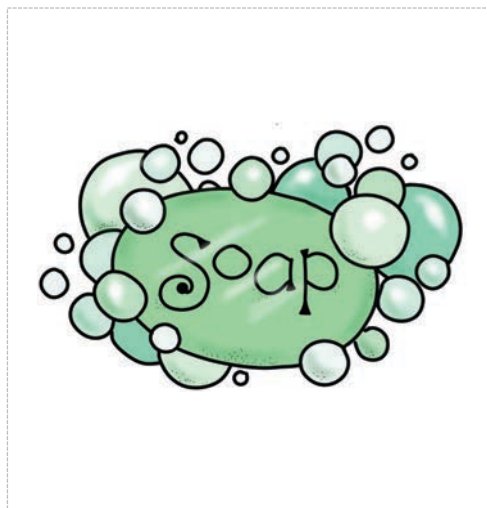
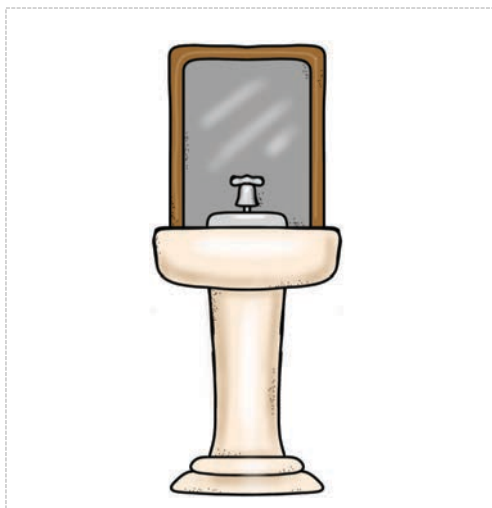

Cut out on the gray dotted line and glue a paddle pop (lollipop) stick to the back. Use the puppets as you write a story on how to send a valentine.

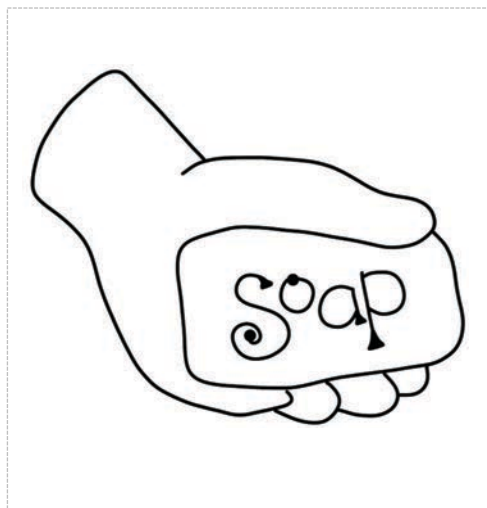
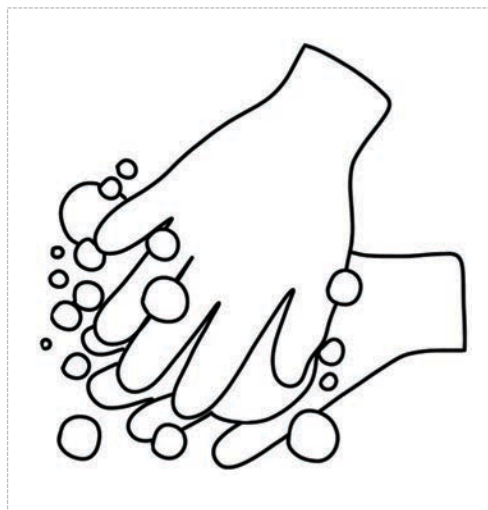
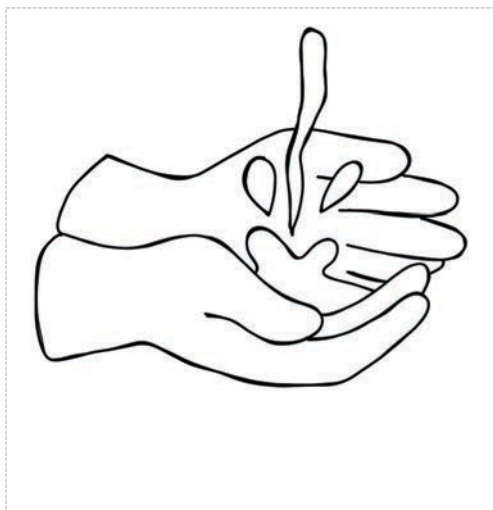

Cut out on the gray dotted line and glue a paddle pop (lollipop) stick to the back. Use the puppets as you write a story on how to send a valentine.

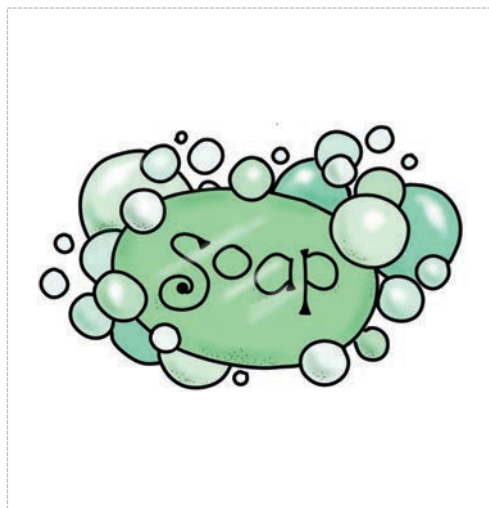
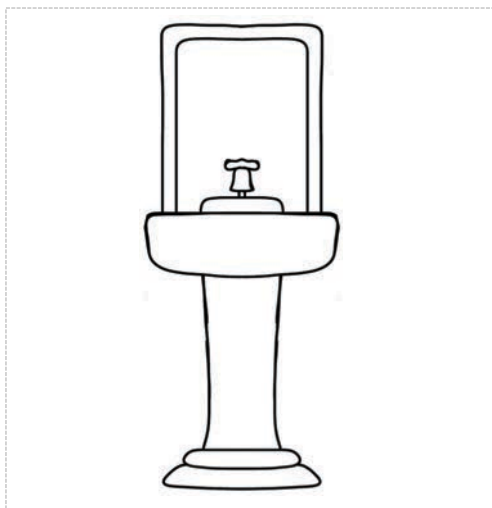
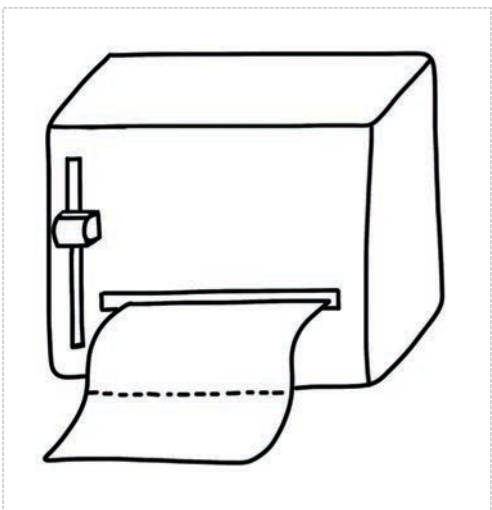
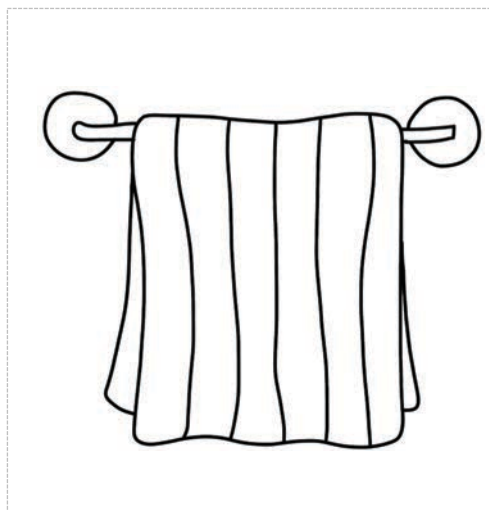

# Writing Practice



water



soap

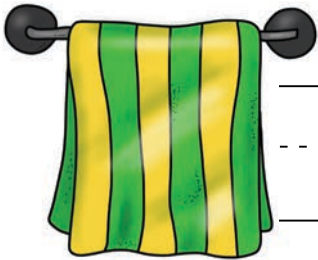

hand towel



soap

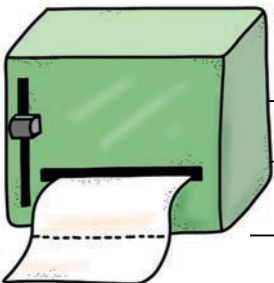

towel

# 3 Part Cards



water



soap



soap



soapy

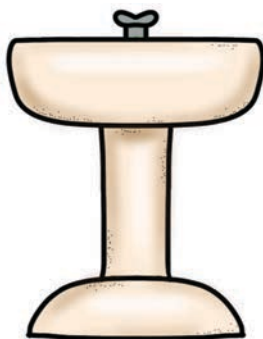

basin



hand towel

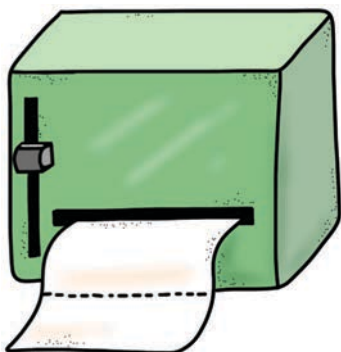

towel

# 3 Part Cards



water



soap



soap



soapy

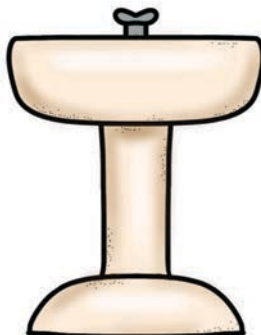

basin



hand towel

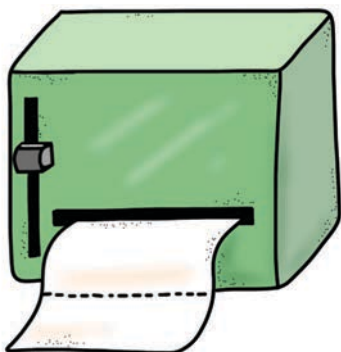

towel

# Sequencing Cards



1st



2nd



3rd



4th



5th



6th



7th



8th

# Sequencing Cards



9th



10th



# Sequencing Cards



first



second



third



fourth



fifth



sixth



seventh



eighth

# Sequencing Cards



ninth



tenth



# Sequencing Cards



Wash  
Your  
Hands

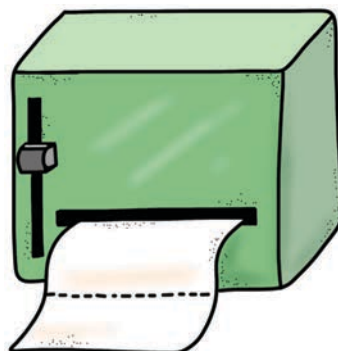



wetting hands

putting soap on



hands



scrubbing and



rinsing



drying hands

# Pocket Chart Cards



soap



soap

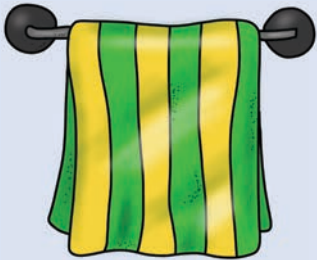

hand towel



paper towel

Wash  
Your  
Hands

Sequencing

Black and White Copies

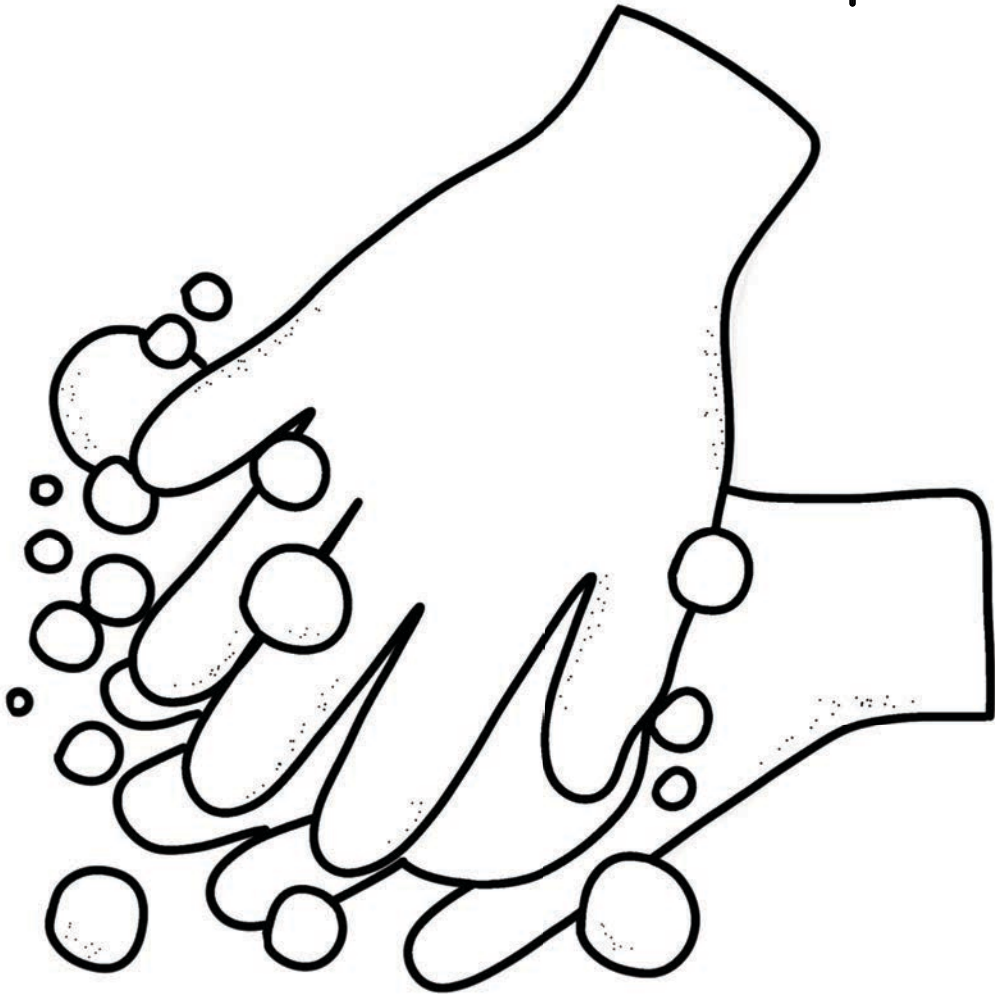

# Sequencing Activity

## How to Wash Your Hands.

Read the story and cut out the pictures and paste in the correct order.

To wash your hands, first you need to turn on the tap and wet your hands. Then, put soap on your hands before rubbing the together. Next you will need to rinse the soap off your hands. Lastly, dry your hands until they are completely dry.

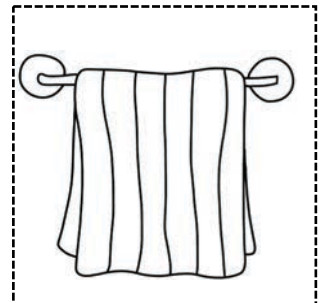
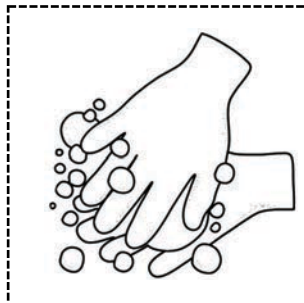
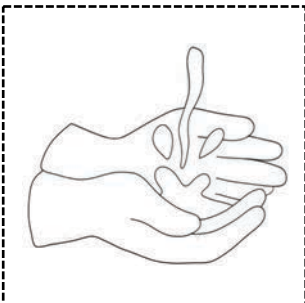
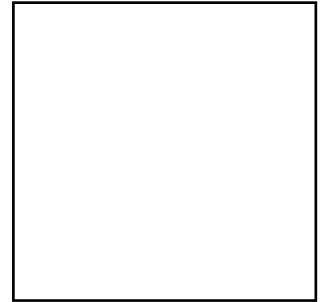
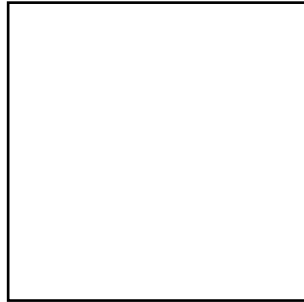
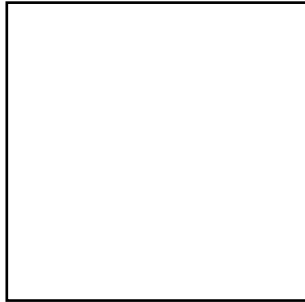
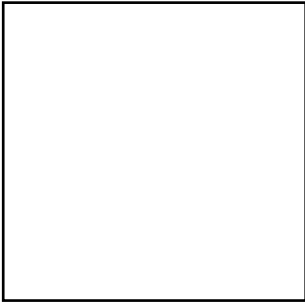

# How to Wash Your Hands

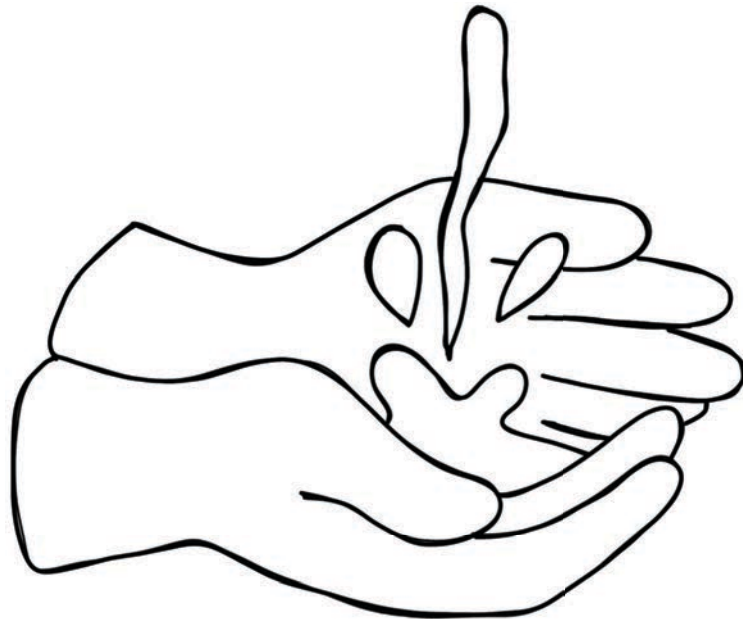

To wash your hands, first turn the tap on and wet your hands.



Then apply soap to your hands and rub it all over. You can use a liquid soap or a cake of soap.

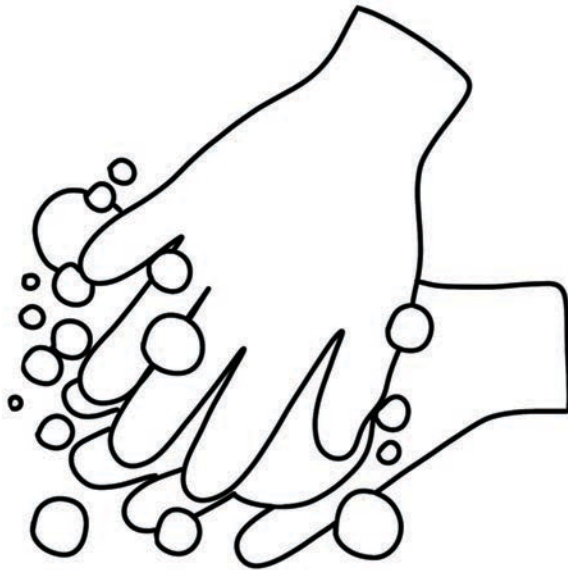

Next, rinse off all the soap.

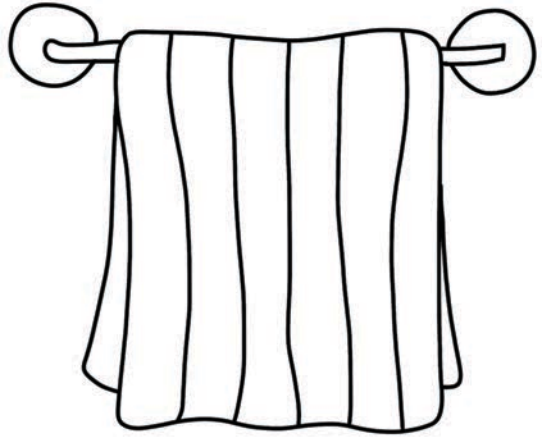
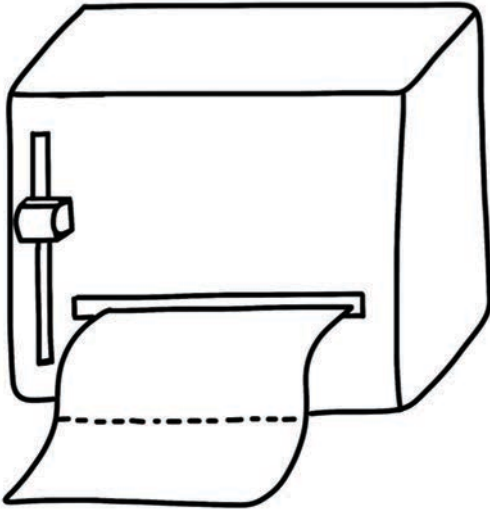

Lastly, dry your hands with paper towel or a hand towel.

# How to Wash Your Hands

Cut out and paste on the previous page.

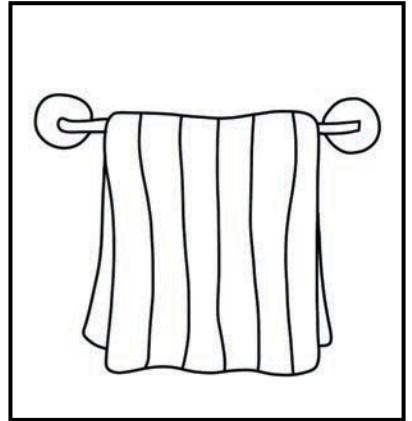
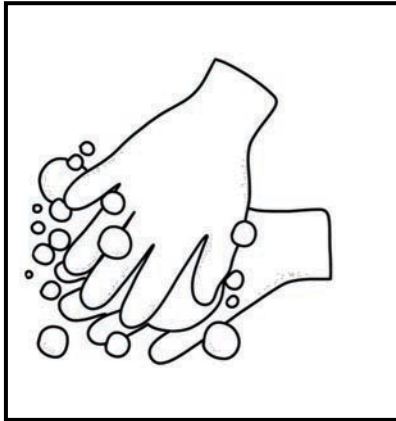
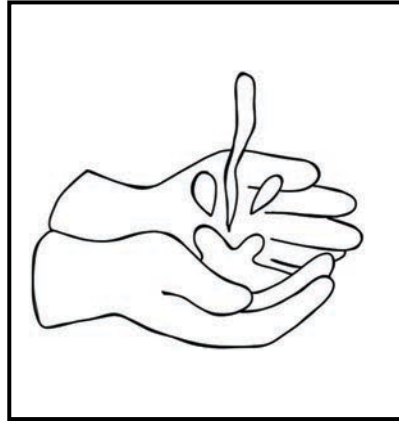
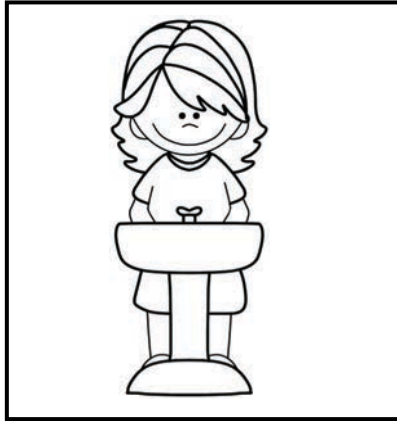

extras ~  
depending on  
what kids what to  
use

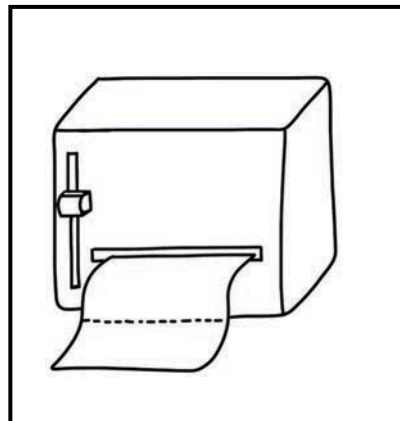

# How to Wash Your Hands

Cut out and paste on the previous page.

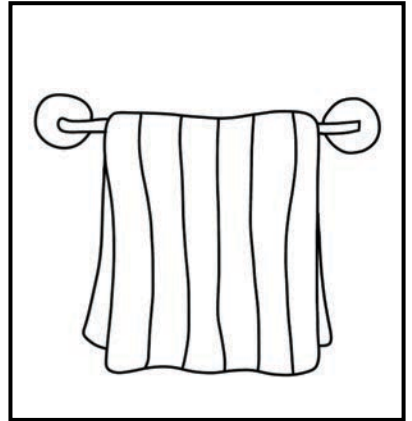
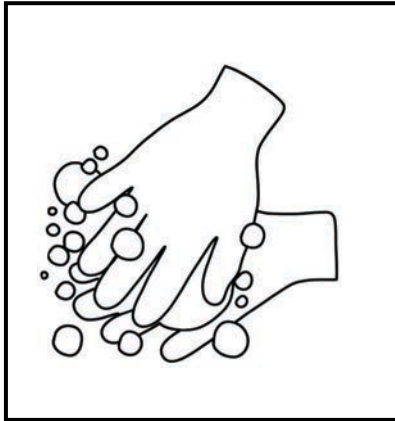
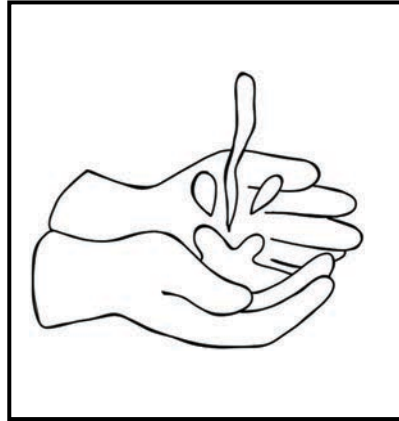

extras ~  
depending on  
what kids what to  
use

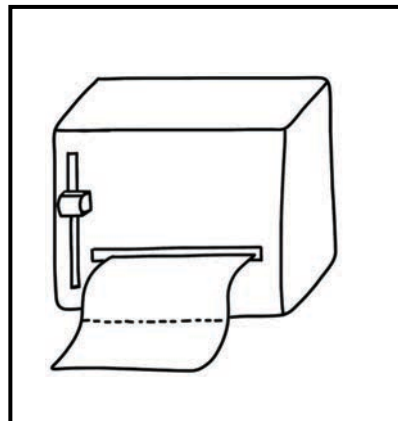

# How to Wash Your Hands

Cut out the boxes below and paste them in the correct order on the previous page.

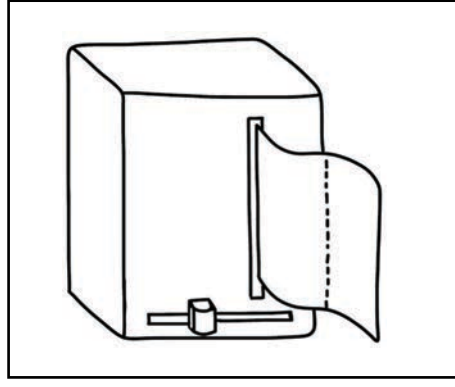
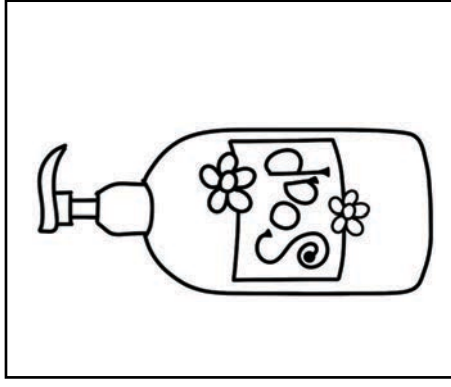
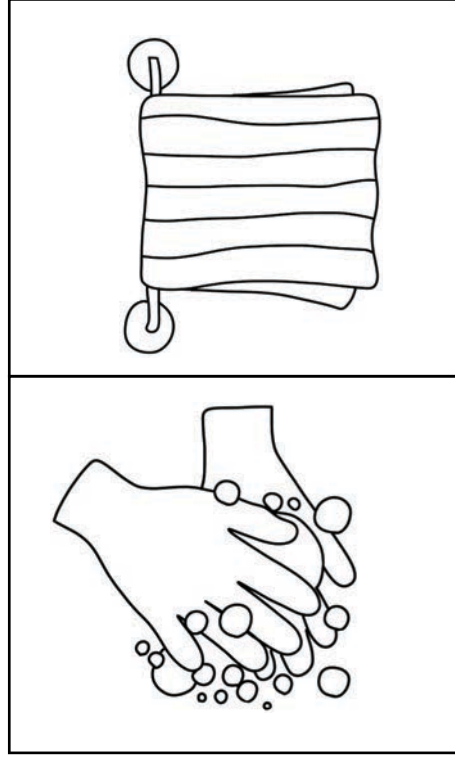
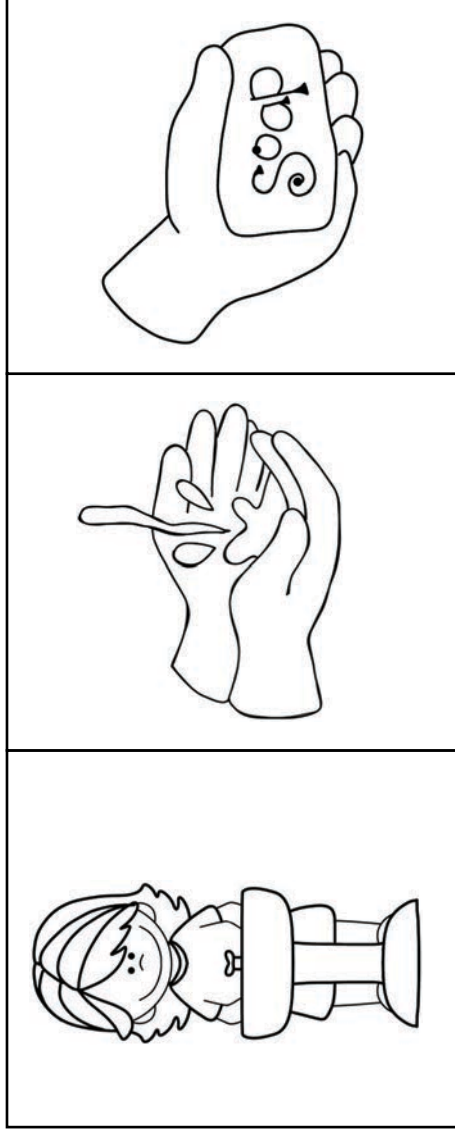

# How to Wash Your Hands

Cut out the boxes below and paste them in the correct order on the previous page.

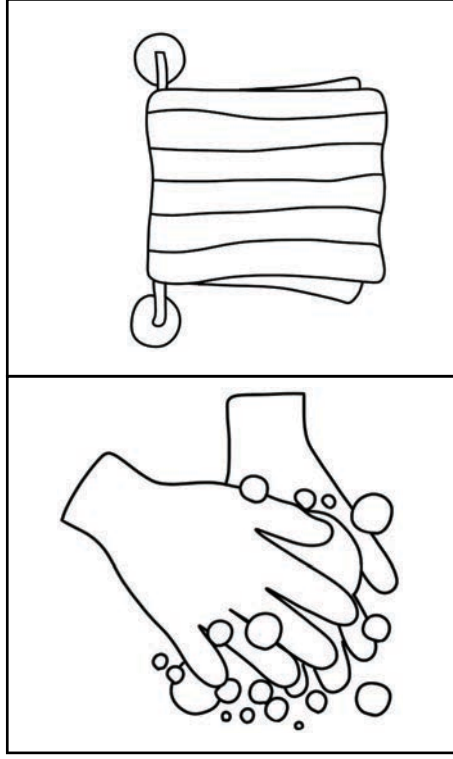
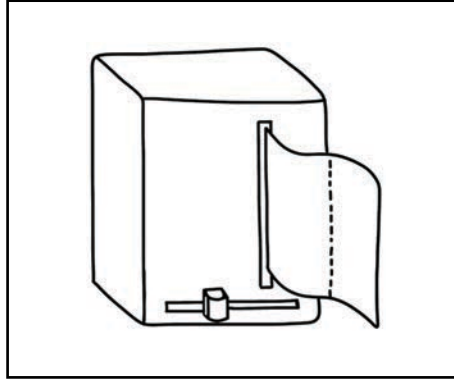
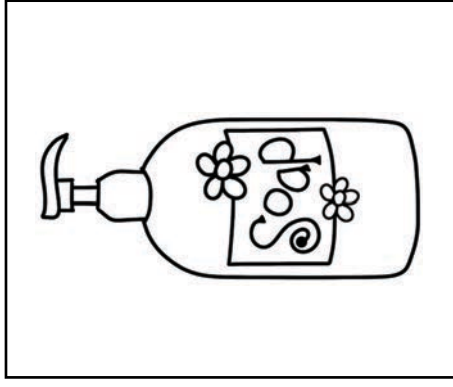
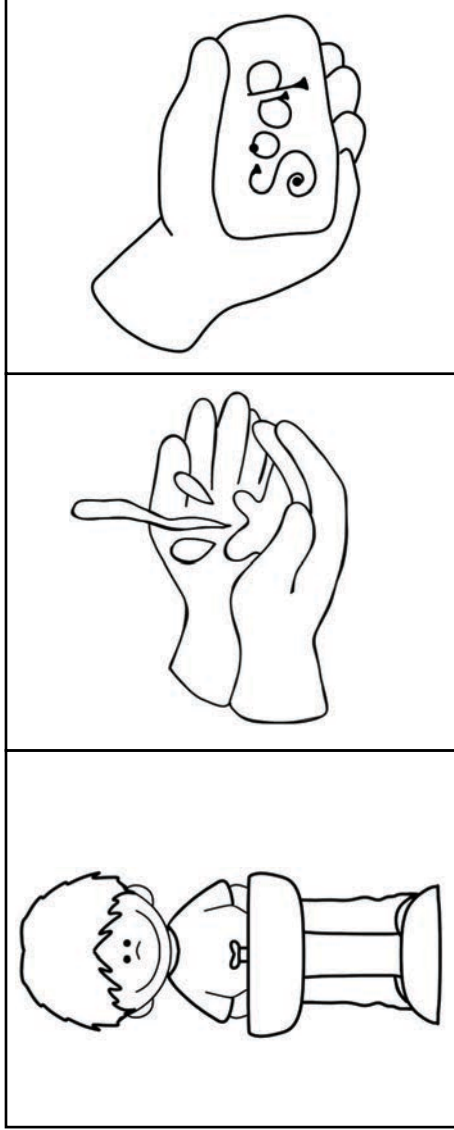

# How to Wash Your Hands Sequencing

Draw a line to connect the picture to the correct order number.

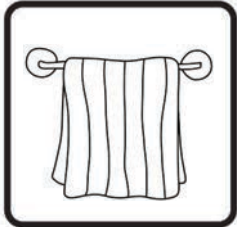

first

second

third

fourth

fifth

# How to Wash Your Hands Sequencing

Draw a line to connect the picture to the correct order number.

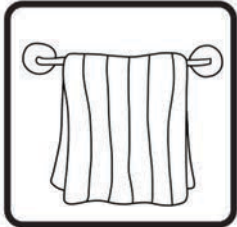

first

second

third

fourth

fifth

# How to Wash Your Hands Sequencing

Draw a line to connect the picture to the correct order number.

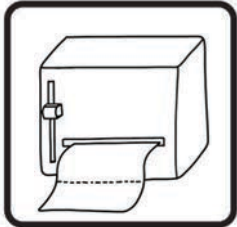
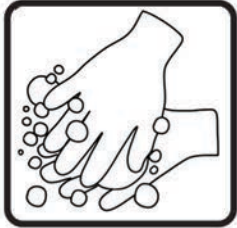

first

second

third

fourth

fifth

# How to Wash Your Hands Sequencing

Draw a line to connect the picture to the correct order number.

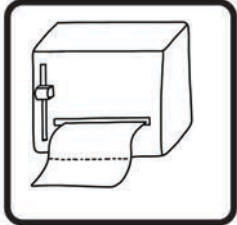
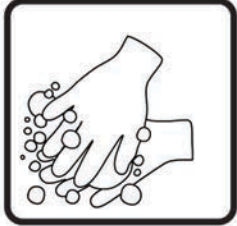

first

second

third

fourth

fifth

Cut out on the gray dotted line and glue a paddle pop (lollipop) stick to the back. Use the puppets as you write a story on how to send a valentine.

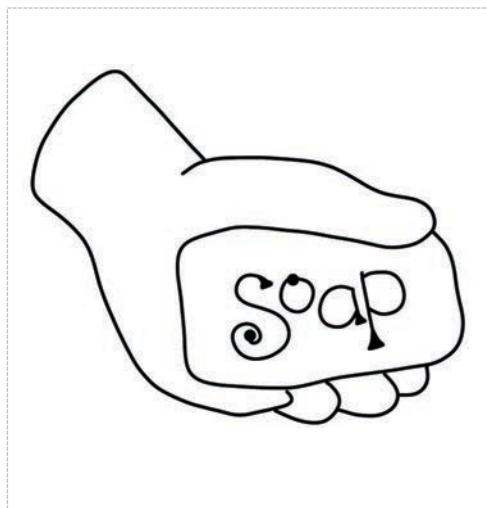
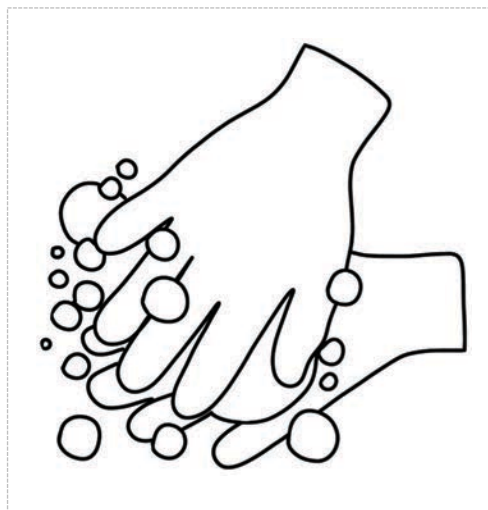
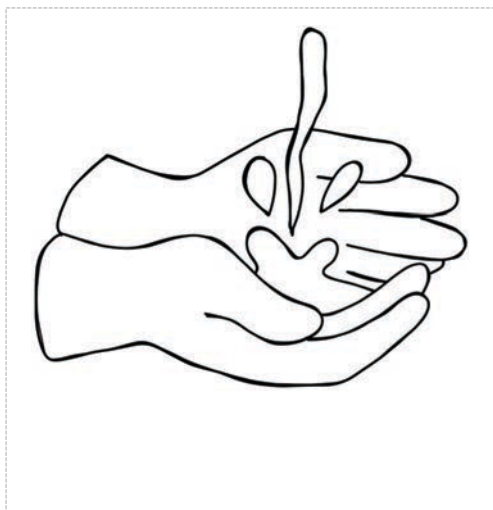

Cut out on the gray dotted line and glue a paddle pop (lollipop) stick to the back. Use the puppets as you write a story on how to send a valentine.

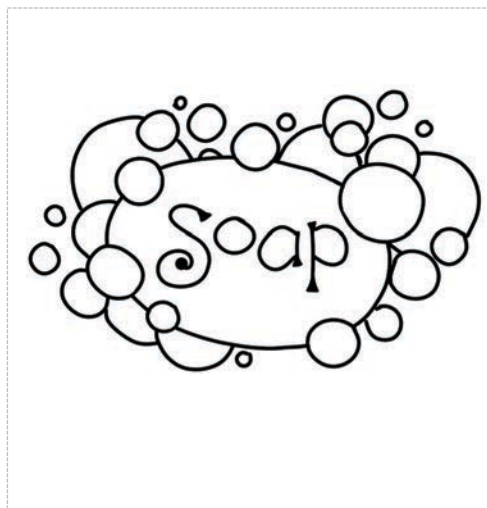
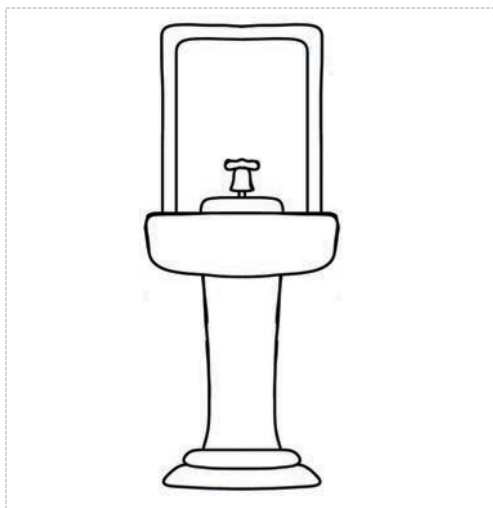
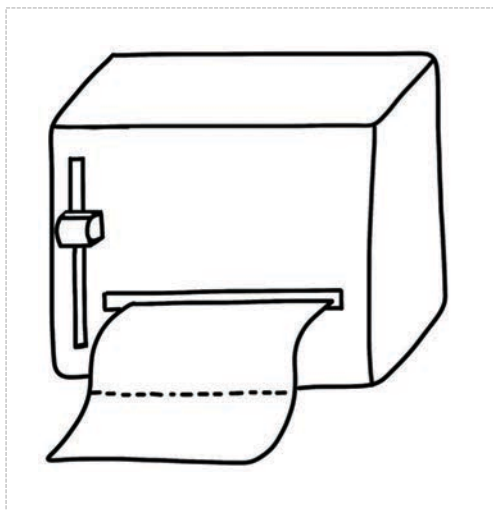
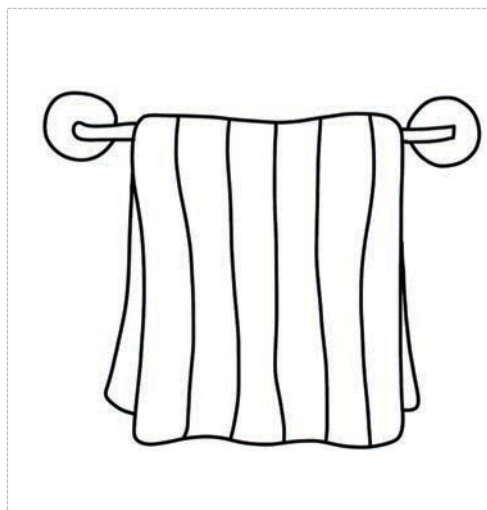

# Writing Practice

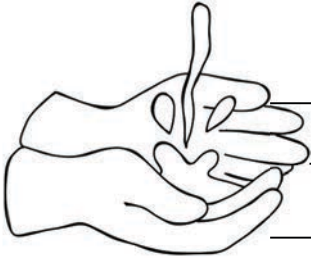

water



soap

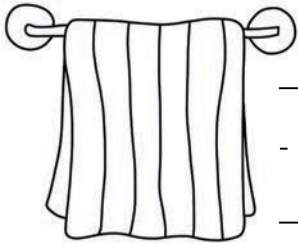

hand towel



soap

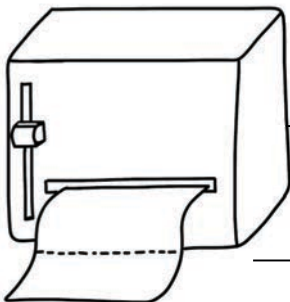

towel

# 3 Part Cards



water



soap



soap

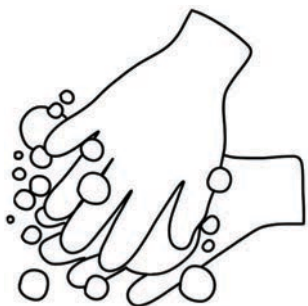

soapy

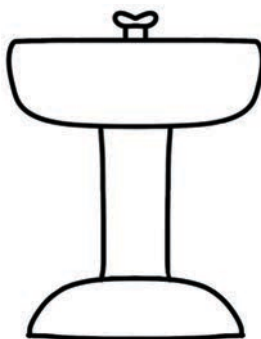

basin

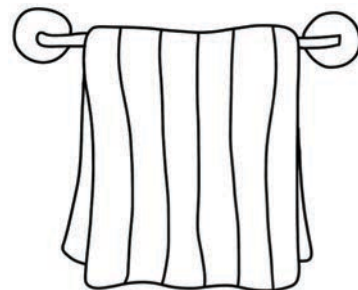

hand towel

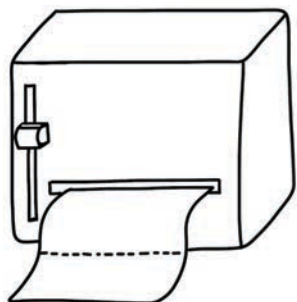

towel

# 3 Part Cards



water



soap



soap



soapy

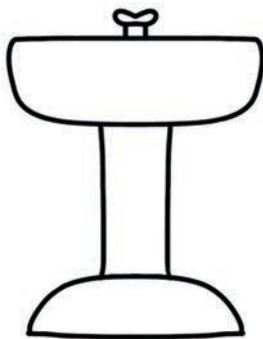

basin

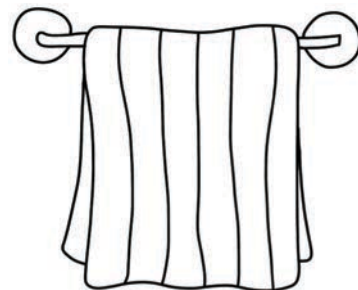

hand towel

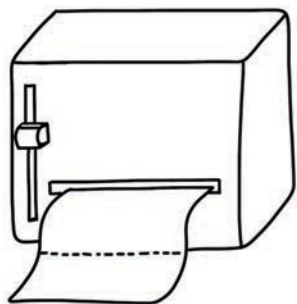

towel

# Sequencing Cards

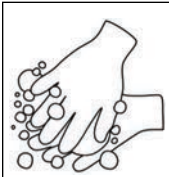

9th



10th

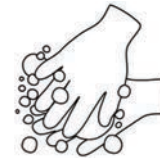
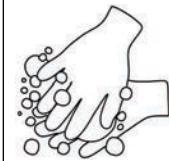
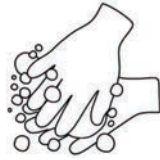
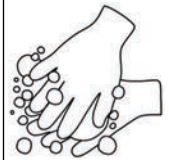
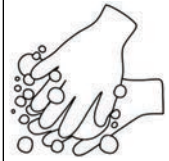

# Sequencing Cards



first



second



third



fourth



fifth



sixth



seventh



eighth

# Sequencing Cards



ninth



tenth



# Sequencing Cards



Wash  
Your  
Hands

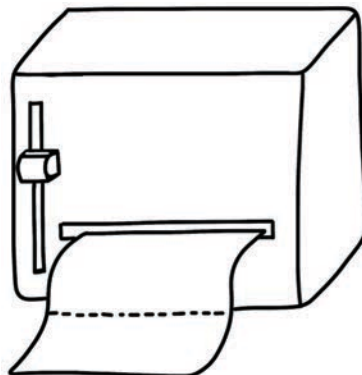
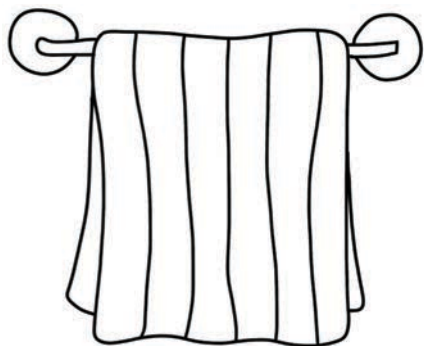
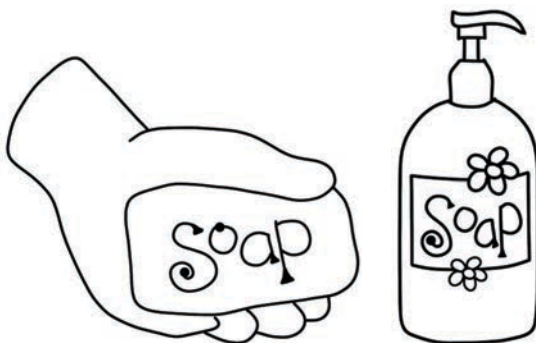
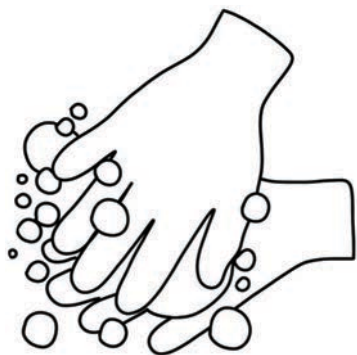
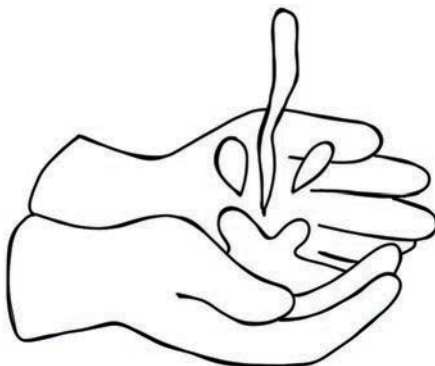



wetting hands

putting soap on



hands



scrubbing and

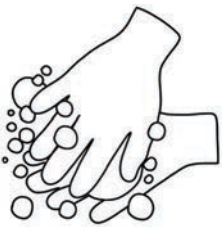

rinsing

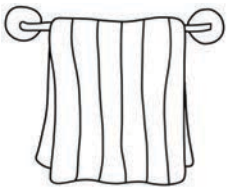
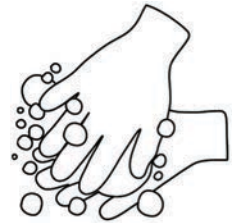

drying hands

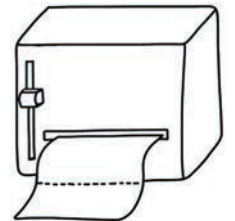

Pocket Chart Cards



soap



soap

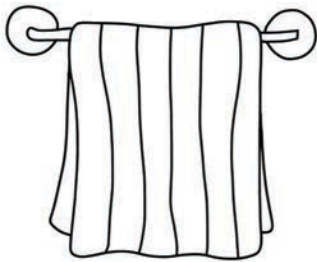

hand towel

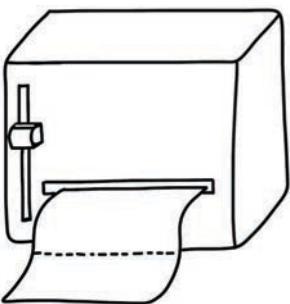

paper towel